

Shadow Diffusion Octagon Floor Lamp Patio Heater

Safety Instructions and Operation Manual
902110



Heat Outdoors
Unit 9, Stort Valley Industrial Estate
Stansted Road, Bishop's Stortford
Hertfordshire, United Kingdom
CM23 2TU

www.heat-outdoors.co.uk
01279 466500
info@heat-outdoors.co.uk

Contents

Brief Introduction	3
Important Information	3
Safety Instructions	4
Assembly Instructions	6
Operation	9
Cleaning & maintenance	10
Storage	11
Technical Specification	11
Customer Service	11

Brief Introduction

Thank you for choosing our Shadow Diffusion Octogon Floor Lamp Patio Heater. This instruction manual will provide you with valuable information necessary for the proper care and maintenance of your new product. Please take a few moments to thoroughly read the instructions and familiarise yourself with all the operational aspects of your new heater.

Important Information

Please carefully read all instructions provided before using this appliance. This heater must be installed in accordance with the instructions and local regulations.

This Operation Manual contains the important information on your safety, as well as some recommendations on the correct use, installation and maintenance of the appliance.

When operating this infrared heater be sure to observe necessary precautions as improper operation with disregard of these precautions may result in harm to health of the user, other people or objects.

Ensure to keep this manual along with your sales receipt, and if possible, cardboard package and packing material in case return of the unit is necessary.

- **Unpack the halogen heater making sure that all the items are present, there are no components left in the box and the heater head is free from any packing material.**
- **Using the detailed diagrams follow the steps to assemble your halogen heater.**
- **Do not connect the halogen heater to the electrical supply until the assembly is complete.**
- **Do not connect the halogen heater to the electrical supply if any of the components or the power cord is damaged in any way.**

Safety Instructions

Read these instructions before using.

WARNING

Potential fire risk if the heater is covered by any material or positioned close to curtains or other flammable materials.

- Only use the halogen heater on a firm solid horizontal area where all the feet on the base are in contact with the floor. (Should the heater be tilted or fall over the auto cut off switch will activate).
- Site the heater outside or in a large open area and well away from any obstructions such as branches or where the heater is near any objects that can be affected by heat, such as furniture, curtains or other inflammable objects (minimum distance 1 metre).
- **DO NOT** use near bath tubs, wash areas or swimming pools.
- **DO NOT** use in unventilated areas
- **DO NOT** use where gas, petrol, paint or other inflammable goods are stored.
- **DO NOT** push any items through, obstruct or cover the grill of the heater head.
- **DO NOT** position immediately above or below an electrical socket.
- **DO NOT** move when connected to an electrical supply and always wait for the patio heater to cool down before storing away.
- **DO NOT** touch the heater head when in use.
- **DO NOT** leave turned on and unattended especially when children and or animals are in the vicinity.
- The indication of the different positions of switches shall be visible from a distance of 1m.
- The marking concerning covering should be visible after the heater has been installed. It should not be placed on the back of portable heaters.
- The unit must be placed with a minimum clearance of 100cm to a wall and 30cm to the ceiling.
- The unit must be correctly installed according to the instructions. Make sure the head is at least 1.8m from the floor.
- The unit must be securely placed on a horizontal and flat surface.
- The unit operates at high temperature during operation. The unit stays hot for a period after shut down. Potential danger will occur when touching it during this period.
- Don't place the unit close to curtain and/or other flammable objects. Otherwise, there will be a danger of catching fire.

- Don't cover the unit with anything during operation or a short time after it's shut down.
- Don't wrap the power supply cord on the unit.
- The unit must be handled with care, and avoid vibration or sudden impact.
- The unit must be securely grounded during operation.
- If the unit gets damaged, it must be repaired by professional electricians.
- When the power supply cord is damaged, it must be replaced by an authorized agent or other professional to avoid danger.
- The unit must not be positioned under a socket.
- When assembling, keep clear from any board or flammable material.
- The unit must not be operated by children or vulnerable people.
- Children and vulnerable people must be supervised at all times.
- It is not safe to install the unit by a swimming pool, in a bathroom or shower area.
- The unit is for household use only. It is not safe to use on a building site, greenhouse, barn or stable where there's flammable dust.
- The head of the unit is at high temperature during operation. Unplug the unit and wait till it cools before cleaning.
- Don't use this unit in place where causticity or volatile air exists, i.e. dust, steam, gas, etc.
- Don't use this unit as a cloth, textile material or towel drier.
- Don't use this unit as a sauna heater.
- Don't use this unit as a room heater.
- Don't use this unit in a place of animal propagating and raising.
- Don't immerse this unit into water for cleaning.
- The unit should be plugged in a socket, which is easily visible and reachable.
- Two dark points may exist on the surface of the heating elements during the first few minutes after it is turned on. This is normal, and will not affect the performance of the unit.
- A tilt switch is fitted inside the unit for safety purpose.

Assembly Instructions

1. Connect 3 pcs of the middle tubing by screwing them together. Then screw tubing to base.
2. Pull the power cord through the pole and base.

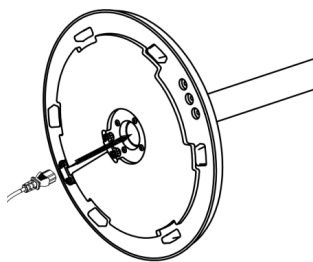
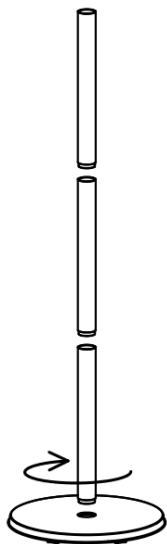

3. Connect the power cord plug to the socket in the heater head.

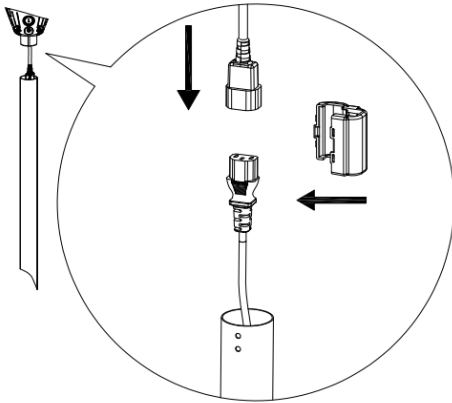

4. Push the heater head onto the pole and fix in position using the $\phi 4 \times 8 \text{mm}$ screws.

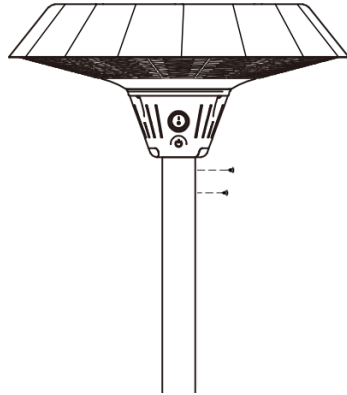

5. Fix the power cord with the press clip in the base.

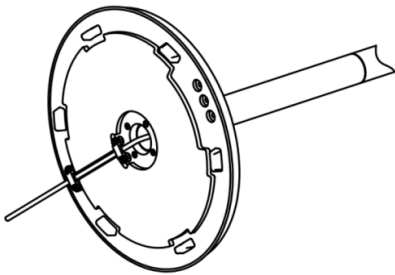

6. To fix the base by pull blasting screw and base retainer plate.

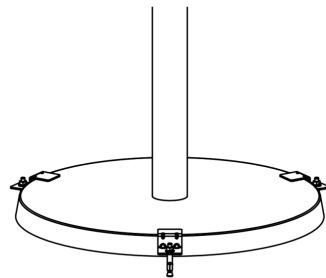

Operation

- Place the heater on a firm, level surface and plug into a grounded 230V 50Hz power outlet. Only operate the heater when it is in the upright position and the base is firmly secured to the floor, in a safe dry area.
- Electric halogen patio heater is equipped with 3 heating settings: Low, Medium and High.

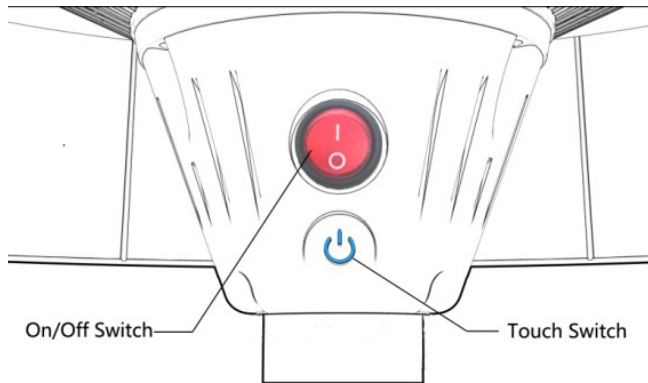

1. Press the **ON/OFF Switch** (I/O) to put the heater into ready mode.
2. Press the **Touch Switch** once. The heater will be on LOW (800W).
3. Press the **Touch Switch** twice. The heater will now be on MEDIUM (1200W).
4. Press the **Touch Switch** three times. The heater will now be on HIGH (2000W).
5. Press the **Touch Switch** four times. The heater will now be set to ready.
6. Press the **ON/OFF Switch** to put the heater into ready mode.

Remote Control Instructions

- Press the **ON/OFF Switch** (I/O), the heater will be in ready mode.
- Press the LOW button of the remote control, the heater will be on 800W.
- Press the HIGH button of the remote control, heater will be on 1200W.
- Press the LOW and HIGH button at the same time, heater will be on 2000W.
- Press the LOW and HIGH button again, the heater will be ready mode.
- Press the **ON/OFF Switch** (I/O), the heater will turn off.

Cleaning & maintenance

Heater housing, grills and internal reflector

- Disconnect the appliance from the power supply system.
- After the appliance has cooled down, the housing can be wiped clean with a damp cloth.
- Do not touch the bulb element with your fingers, since stains could build up from such a contact and may cause malfunction of the bulb.
- Do not use any abrasive or hard cleaning products on any part of this heater.
- Do not immerse the appliance in water.
- Wait until the unit is completely dry before use.

Cleaning of heater lamp

- Disconnect the appliance from the power supply system.
- Wipe the lamp over with a damp cloth ensure no detergents or cleaning fluids are used as they may cause damage to the lamp coating.

<https://www.heat-outdoors.co.uk/help-desk/useful-articles/heater-and-lamp-maintenance.html>

Any maintenance or repairs should only be carried out by a qualified electrician if you're unsure how to do so. For further information and guidance, visit our online help articles and videos.

Disposal



In accordance with European Directive 2001/96/EG concerning used electrical and electronic appliances (waste electrical and electronic equipment – WEEE), please return any electrical equipment that you will no longer use to the collection points provided for their disposal.

This symbol indicates that the appliance cannot be treated as normal domestic trash, but must be handed to a collection point for recycling electric and electronic appliances.

Information concerning where the equipment can be disposed of can be obtained from your local authority.

Storage

If the heater will not be used for a long period of time, store it in a cool, dry location. To prevent dust and dirt build-up, use the original packaging to repack the heater.

Technical Specification

Ratings: 220-240V AC 50-60Hz

Power consumption: 800/1200/2000W

Net weight: 15 kg

Insulation: Class 1

Ingress Rating: IP45

Customer Service

- Repairs must be carried out by authorized specialists, thus ensuring electrical safety.
- Please contact us or a suitably qualified electrician.
- Improper repairs could lead to danger to the user.

Warranty does not cover damage of failure which results from alteration, accident, misuse, abuse, neglect, commercial use or improper maintenance. In line with our policy of continuous product development we reserve the right to change the product and documentation specifications without notice.



Heat Outdoors

Unit 9, Stort Valley Industrial Estate
Stansted Road, Bishop's Stortford
Hertfordshire, United Kingdom
CM23 2TU

www.heat-outdoors.co.uk
01279 466500
info@heat-outdoors.co.uk